

JLR-31 GPS compass

3D
Dynamic Sensor™

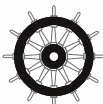

- the JLR-31 sets a new standard of GPS compass, with its renowned high performance and new features

5.7-inch high visibility display

Roll, pitch, rate of turn and heave integrated

High speed tracking response (ROT 45°/sec)

Wide range of new display modes available

Dynamic heading accuracy 0.25° rms

JLR-31

- features

Features

The JLR-31 GPS compass continues the success of its predecessor, reaching a new level of performance and stability with many new features and enhancements. This system is also known as a 3D Dynamic Sensor™, which besides giving heading information, is designed to provide highly accurate information of the ships movement in all axis.

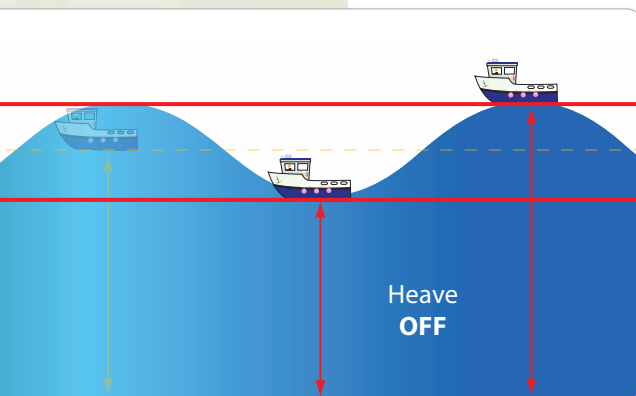

Heave compensation

The JLR-31 has heave functionality built-in as standard. In rough ocean conditions (with high waves), the GPS compass can correct up and down (attitude), movement. This is especially useful for fish finders and sonars on fishing vessels where high waves are compensated for

with up to 20 cm accuracy, providing better potential for a profitable catch.

Sentence

ATT
HVE

Data

Heading, rolling, pitching
Heaving

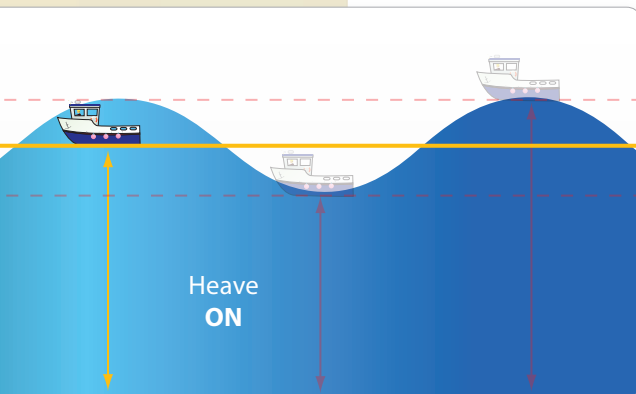

High speed update

The JLR-31 supports Speed Over Ground (SOG) and Course Over Ground (COG). The position, SOG and COG are updated every 200 milliseconds (which is 5 times faster than previous model JLR-30), delivering high accuracy.

Data

Heading, ROT, rolling, pitching, heaving
Position, SOG, COG

Cycle

Every 20 milliseconds
Every 200 milliseconds

High speed tracking

The GPS compass has its origins as a direction sensing system, but the JLR-31 goes far beyond that. The JLR-31 provides an impressive heading accuracy of 0.25°. Our other model (JLR-21) has an 0.5° heading accuracy. Heave accuracy is 20 cm or better and roll and pitch for both models is 0.5°. The tracking Rate of Turn (ROT) is 45° per second.

On the right a comparison between previous GPS compass model (JLR-30) and the new model (JLR-31).

Features

Roll
Pitch
Rate of Turn
Position
Heave
High speed update
Trip log
Anchor watch
CCRP
RMS
Trend graph

JLR-30

✓
✓
✓
✓

JLR-31

✓
✓
✓
✓
✓
✓
✓
✓
✓
✓
✓

JLR-31

- advanced technology

Display modes

The JLR-31 incorporates many display modes readily available on a highly visible 5.7 inch LCD display. The display is fully dimmable and the keys are also backlit, making it easy to operate in low-light settings on the bridge.

Simple operation

The compact design of the JLR-31 incorporates an intuitive interface, providing enhanced ergonomics and user friendliness. The logic of the controls and excellent on-screen menus will greatly shorten most users' learning period.



Antenna design

The processor is built into the antenna. Eliminating alignment between antenna and processor found in separate systems, therefore contributing to an easy setup with less error and significantly reduced installation time. This concept also reduces the installation costs as only a single cable is used between antenna and display unit.

The outer shell of JRC's new antenna system has a smooth surface. This slippery exterior makes it almost impossible for birds to perch on the domes or for the antennas to be completely covered in snow.

Should something interfere with the coverage, JRC's proven antenna design incorporates a layer of air that reduces possible blind spots, allowing for a more precise heading than conventional systems.

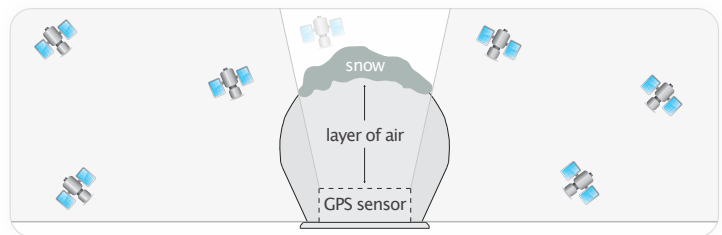

· JRC proven high performance antenna design

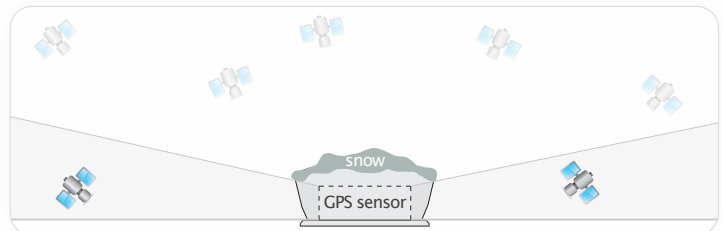

· Conventional antenna system



NNN-31

Installation and maintenance

The JLR-31 display is compactly designed and can be mounted virtually anywhere. The three-antenna system is exclusively designed by JRC, making it far more reliable than conventional antenna systems. The system has a short start-up time (less than 2 minutes). Maintenance is not required, making it less expensive to maintain than a standard gyro system.



Remote Maintenance System (RMS)

JRC has the ability to cost-effectively monitor performance and functionality of the JLR-31 while at sea, significantly reducing downtime and maintenance costs. More at jrceurope.com/support ▶

JLR-31

- unique functions



Measuring tool

The GPS compass allows calculation of distance and bearing between any two points, supporting Rhumb Lines (RL) for the short legs and Great Circle (GC) for long distance legs. Also, a trip log function comes standard for distance and heading.

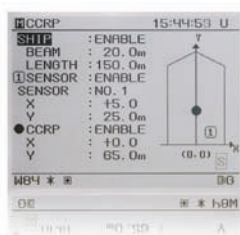

CCRP and Anchor watch

The JLR-31 has CCRP¹ function incorporated, allowing the transfer of CCRP sentences to other onboard equipment and anchor watch alerts the watch officer of possible anchor dragging situations.

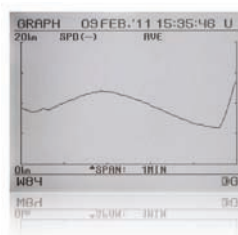

Trend graph

The new trend graph display mode shows a history of roll, pitch and heave and SOG as an easy-to-read graphical view. Selections can be made to show maximum or average results.

Interfaces

The new GPS compass integrates 5 independent working NMEA output ports, which allows for connection to a wide range of onboard navigation equipment, such as radar, plotter, autopilot, sonar or other navigation devices.

JLR-31 and IMO recommendations

Traditionally, the means used to measure the heading of a ship has been a mechanical gyrocompass and/or a traditional magnetic compass. With the adoption of the new installation requirements in SOLAS-V, all passenger ships and all ships from 300 to 500 GT travelling international routes can now install a new technology directional sensor, the Transmitting Heading Device (THD). JRC's new JLR-31 has been approved as both a THD and a GNSS (GPS).

The approval allows for installation as a primary heading device on vessels up to 500 GT and for vessels over 500 GT, two or more could be installed as GNSS (GPS) or backup heading device depending upon flag/class agreement.

	GPS compass	Gyro compass	Magnetic compass
Periodic maintenance	No	Yes	Yes for correction deviation
Settling time	approx 2 min.	about 4 hours	no
Tracking response	High speed	High speed	Low speed
Accuracy	Good	Good	Bad
Magnetic influence	No	No	Yes
Correction	No	Yes for latitude	Yes for variation

Standard in the box

- Display
- Antenna
- Cables
- Installation parts
- Spare parts
- Manual

Cables

- Power cable display 2 m
- Serial data cable 3 m
- Display to antenna² 10 m

Options

- Serial data cable CFQ-5374 (3 m)
- Sensor extension cable CFQ-7250 (20 m)
- Flush mount kit MPBC43664
- AC power rectifier NBG-320
- DGPS receiver JLR-4341

See all options jrceurope.com

1. Consistent Common Reference Point

2. The cable length may vary depending on sales region.

JLR-31

- size and weight

Display

NWZ-4701 Weight 2,3 kg

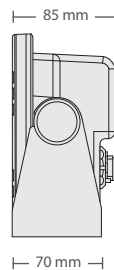
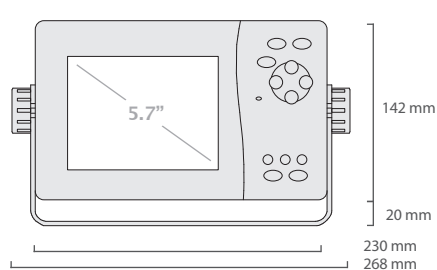

Cutout dimensions for flush mounting

Height	116 mm
Width	220 mm
Depth	64 mm

Antenna

NNN-31 Weight 10 kg

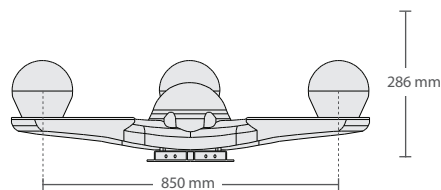
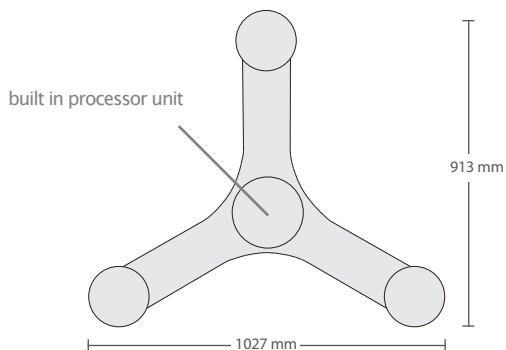

System diagram

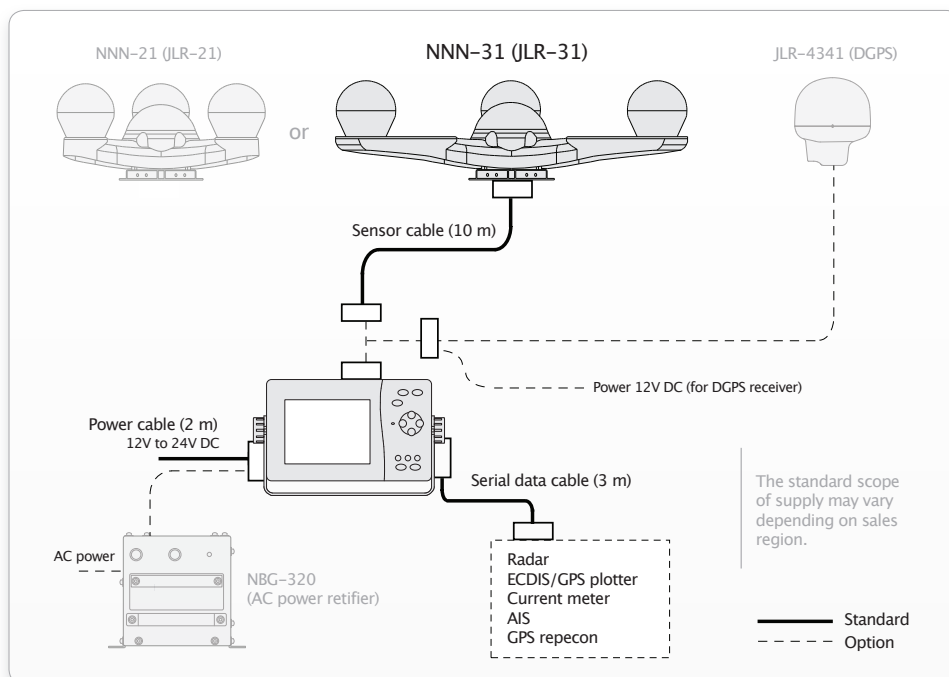

The maximum cable length between antenna and display is 50 m. Note that extensions should be of a shielded multicore cable to prevent noise or attenuation.

JLR-31

- specifications

	JLR-31
IMO approved	✓
Receiver type	Multi channel all-in-view (12ch + 1ch SBAS)
Frequency	1575.42MHz ± 1MHz (C/A code)
Direction accuracy	0.25° rms
Display resolution	0.1°
Resolution output	0.1° or 0.01° (selectable)
Tracking Rate of Turn	45°/sec
Tracking acceleration	1G
Roll/pitch output	-60° to 60°
Startup time	less than 2 minutes (warm start fix)
DGPS input	RTCM SC-104 version 2.0 (type 1, 2, 9, 16)
SBAS receiver	Built-in (WAAS/EGNOS/MSAS)
RAIM function	Built-in
Position accuracy	12m 2drms (C/A code, HDOP=<4, SA OFF) 6m 2drms when SBAS corrected 4m 2drms when DGPS corrected (when connected to beacon receiver)
Display	5.7-inch LCD, 320 by 240 pixels
Operating keys & backlight	12 keys, LED (display and backlight keys)
Dimmer levels	4 levels (bright, medium, dark, off)
Display modes	Compass rose, bow heading, navigation, rate of turn (ROT), water/ground speed, trend graph, calculation, GPS status
Output ports	5 independent working NMEA0183 ports
NMEA0183 version	1.5, 2.1, 2.3
Transmission speed	4800, 9600, 19200, 38400, 57600 bps
Output interval	20ms, 25ms, 50ms, 100ms, 200ms, 500ms, 1s, 2s, 3s, 4s, 5s, 6s, 7s, 8s, 9s
Sentence ¹	IEC61162/NSK (shared) 5 ports (AD10 output available: 2 of 5 ports) IEC61162 output: HDT, THS, ROT, ZDA, GGA, VTG, RMC, GBS, DTM, GSA, GSV, GNS, MSS, GST, GLL, ALR, ATT, HVE
Current data input	1 port (CUR, VBW)
Alarm contact signal	2 ports (alarm output), 1 port (ACK input)
LOG pulse	1 port (off, 200p/nm, 400p/nm)
Power	12V to 24 V DC (-10% to +30%)
Power consumption	12 W (including sensor), 6 W (excluding sensor)
Ambient conditions	-15° to 55°C (operating), -25° to 70°C (storage)
Waterproof	IPX4 (display), IPX6 (sensor)

1. Selectable sentences depend on version. ATT and HVE sentence can be set from output cycles of 25ms, 100ms, 200ms, 1s, 2s only. Some combinations of output sentence, bit rates, and output intervals may not be possible.

JRC in Europe/Africa
Cessnalaan 40-42
1119 NL Schiphol-Rijk
The Netherlands

T +31 20 658 0750
F +31 20 658 0755
W jrceurope.com

JRC in Asia/Oceania
Fujisawa bldg. 30-16
Ogikubo 4-chome Suginami-ku
Tokyo 167-8540, Japan

T +81 3 6832 1721
F +81 3 6832 1845
W jrc.co.jp

JRC in the Americas
1011 SW Klickitat Way, B-201
Seattle, WA 98134
USA

T +1 206 654 5644
F +1 206 654 7030
W jrcamerica.com